

Montaż dolnych wózków

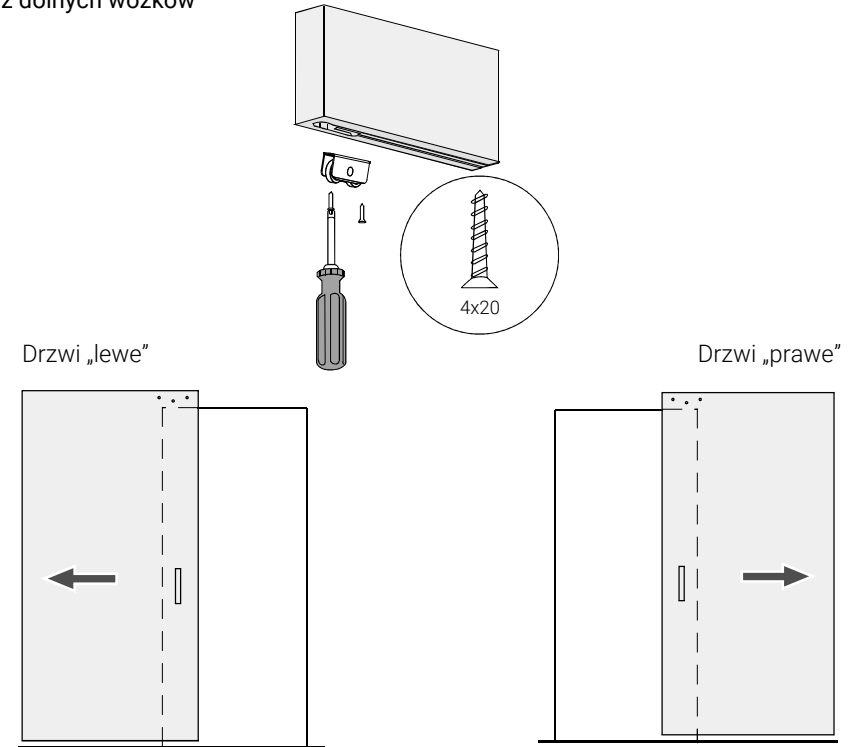

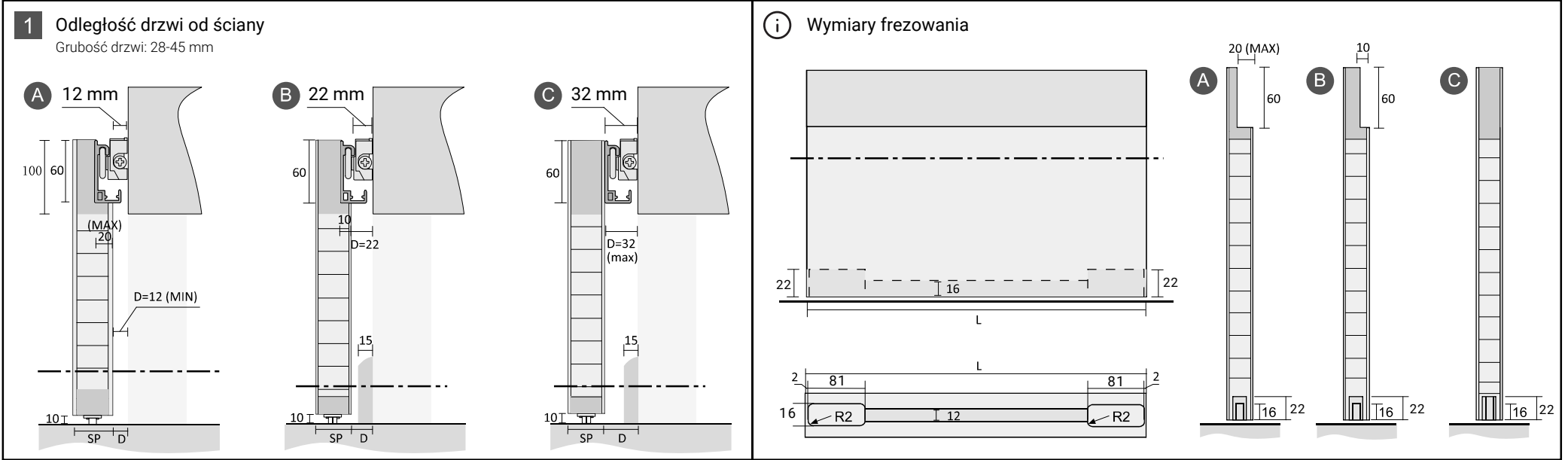

2

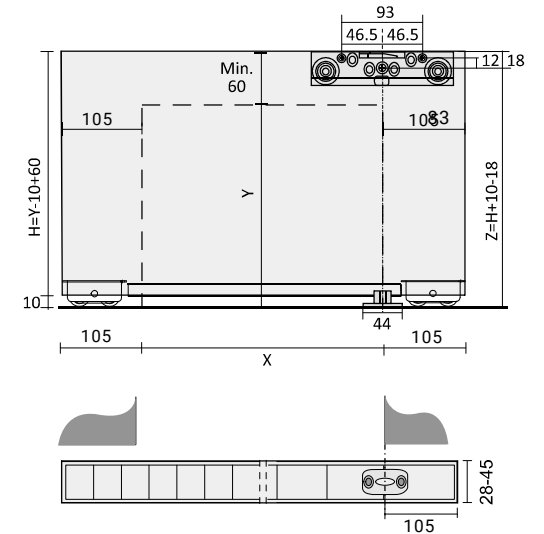
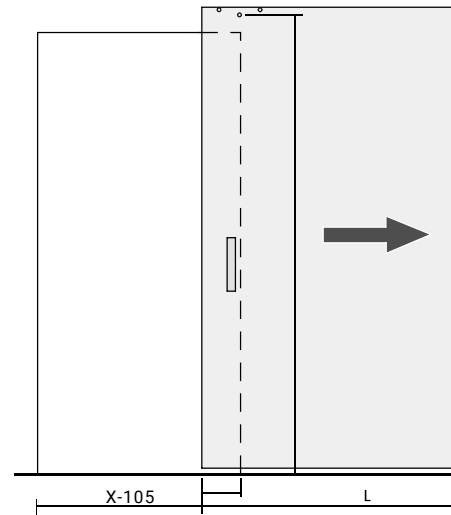
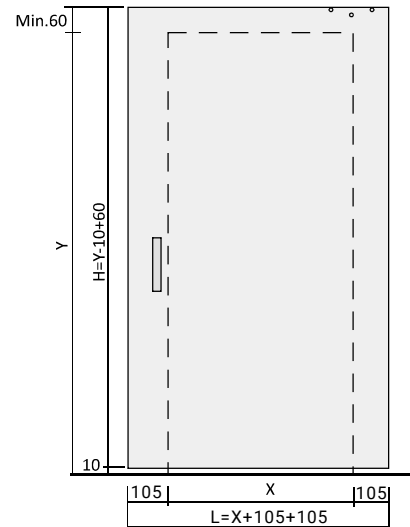
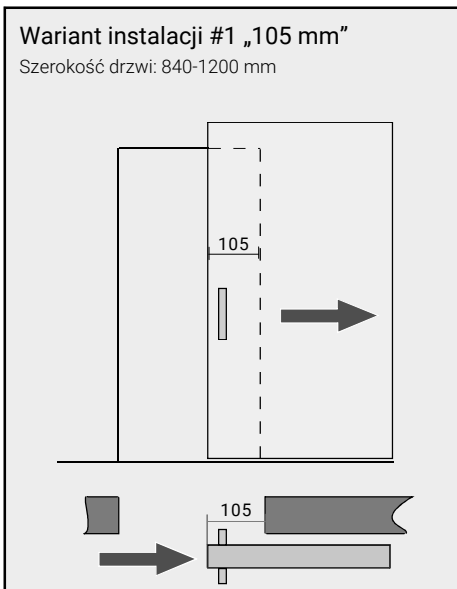

Wariant instalacji #2 „60 mm”

Szerokość drzwi: 800-1200 mm

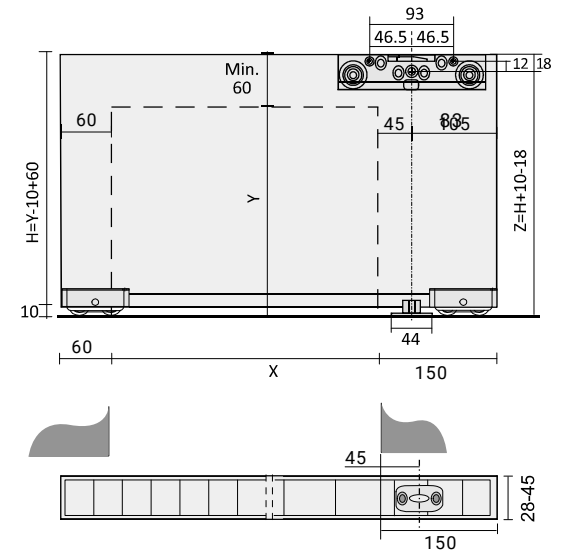
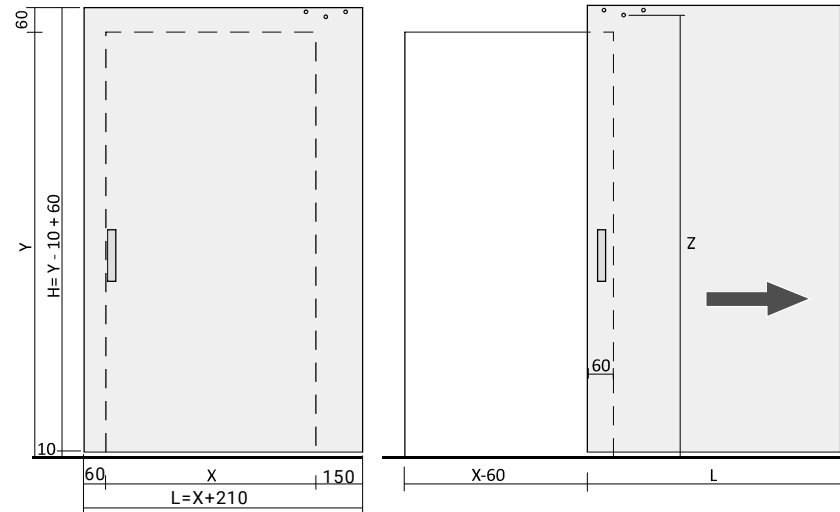
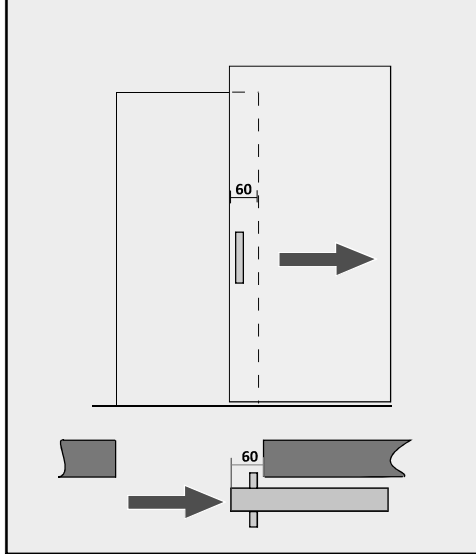

Wariant instalacji #3 „0 mm”

Szerokość drzwi: 800-1200 mm

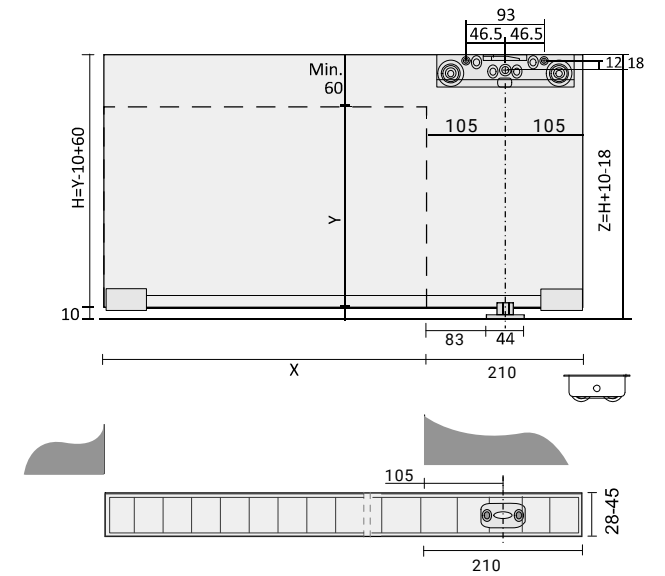
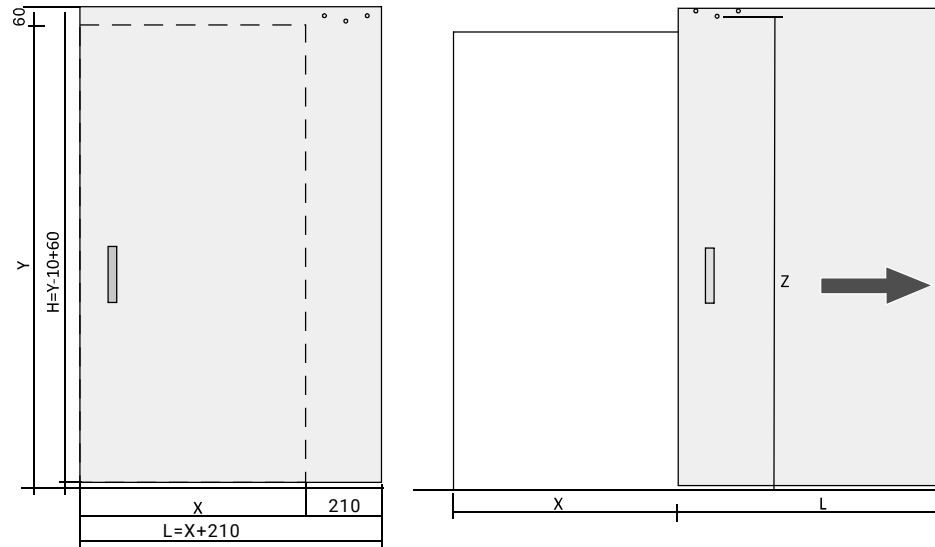
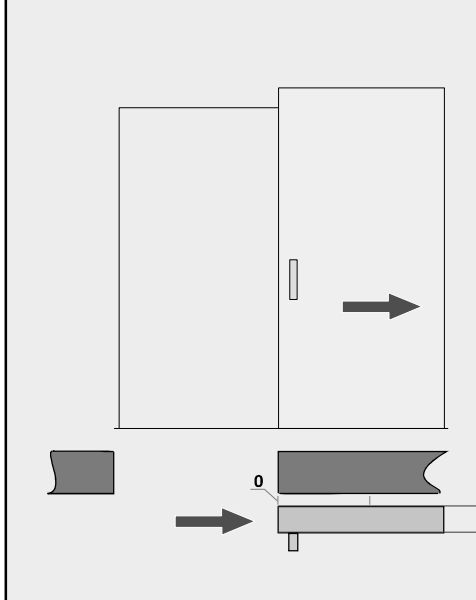

3 Montaż skrzydła drzwi

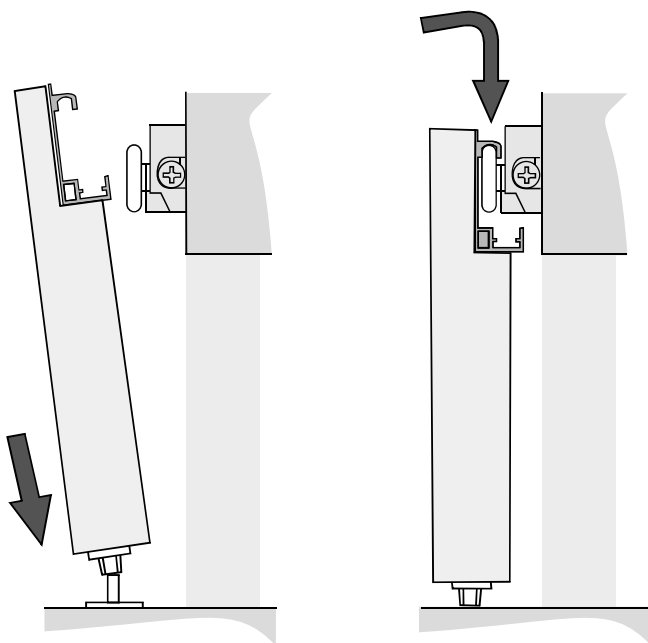

4 Regulacja wysokości

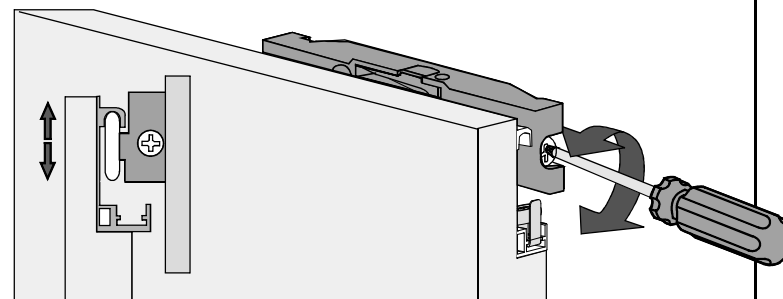

Aktywuj element, który zapobiega wypadnięciu drzwi

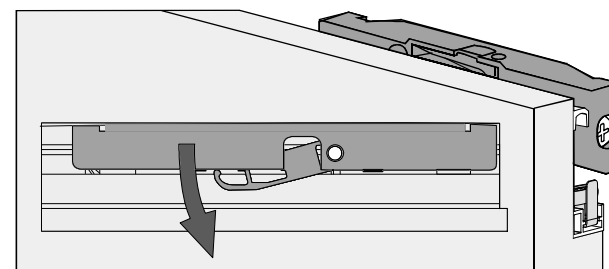

5 Instalacja domykacza i haka

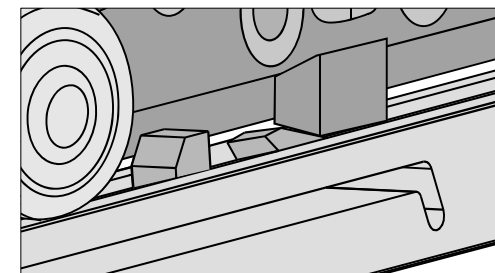
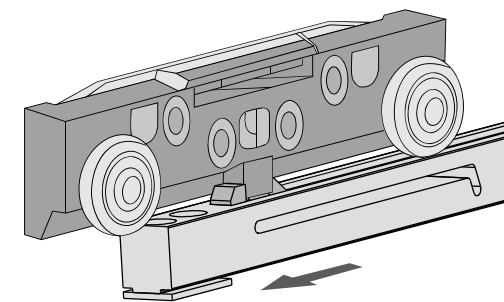

6

6.1 Instalacja domykacza

6.2 Instalacja zaślepek bocznych

6.3 Instalacja podkładek korygujących nachylenie ściany

